

Specifications:

Current Rating: 3.2A AC/DC
 Voltage rating: 350V AC/DC
 Temperature range: -25°C to +85°C
 Contact resistance: 20mΩ max.
 Insulation resistance: 1000MΩ min.
 Withstand voltage: 1500V AC/minute
 Package: tape & reel

Material:

Housing: LCP, UL94V-0, beige
 PIN: brass
 Solder tab: brass

Mates with: 1801W (wire connector)
 1801WL (wire connector, with lock)

Part Number Information:

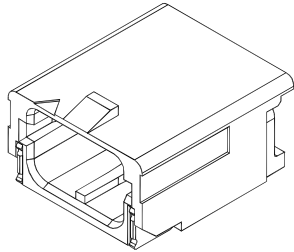
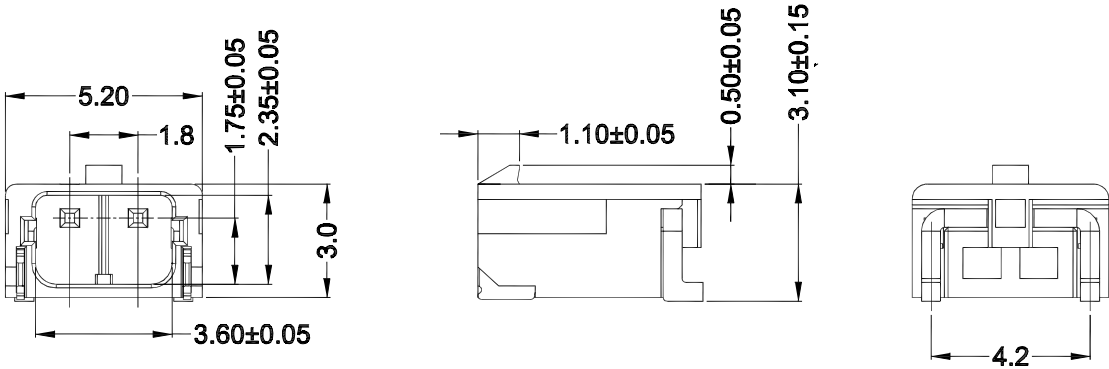
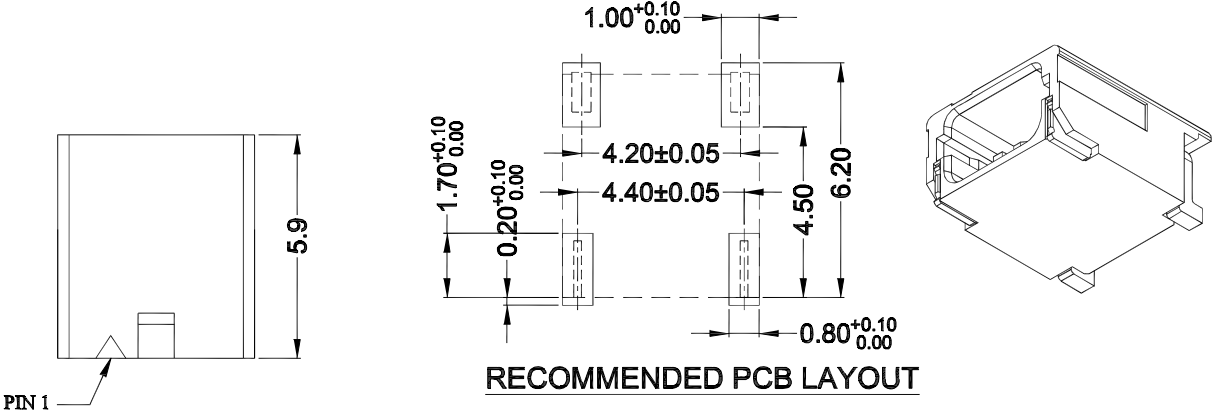
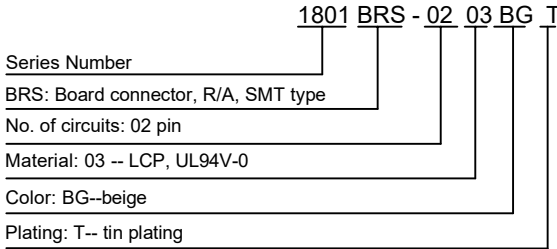

							General Tolerance	<h1>Zeakka Electronics</h1>				Document No.: ZK-1801BRS		
							.X ±0.3					Title: HEADER, R/A, SMT TYPE, SINGLE ROW, 1.80MM PITCH, TIN		
							.XX ±0.2					APPR	CH'K	DRWN
Date	Version	EC No.	Description	DRWN	CH'K	APPR	.XXX ±0.1	Kai Lee	Cris Wang	Jun Wei	2020.8.7	mm	1:1	A

THIRD ANGLE PROJECTION

Specifications:

Current Rating: 3.2A AC/DC
 Voltage rating: 350V AC/DC
 Temperature range: -25°C to +85°C
 Contact resistance: 10mΩ max.
 Insulation resistance: 1000MΩ min.
 Withstand voltage: 1500V AC/minute

Material:

Housing: nylon 66, UL94V-0, white

Mates with: 1801BRS (header, R/A, SMT type)

Used with: 1801TF-PT (female terminal)

Part Number Information:

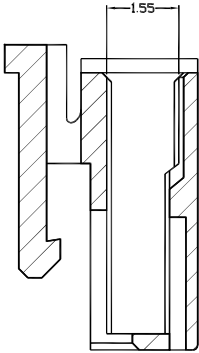
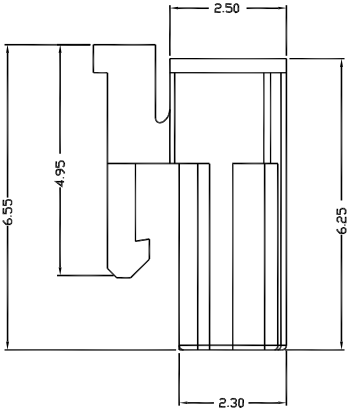
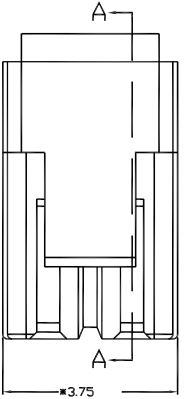
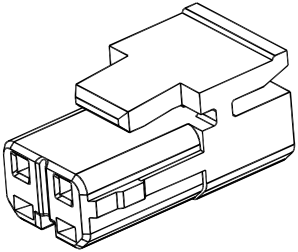
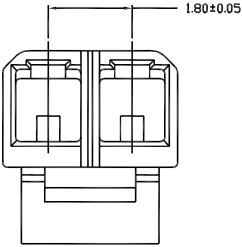
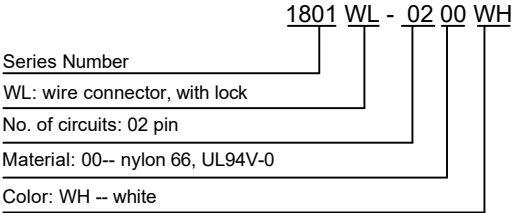

SECTION A-A
 SCALE 1:1

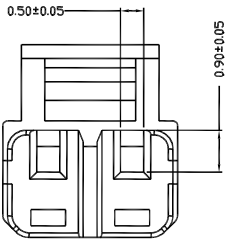

							General Tolerance	<h1>Zeakka Electronics</h1>				Document No.: ZK-1801WL						
							.X ±0.3					Title: HOUSING, FEMALE, CRIMP TYPE, SINGLE ROW, 1.80MM PITCH						
							.XX ±0.2					APPR	CH'K	DRWN	Date	Dimensions	Scale	Version
							.XXX ±0.1					Kai Lee	Cris Wang	Jun Wei	2020.8.7	mm	1:1	A
Date	Version	EC No.	Description	DRWN	CH'K	APPR	THIRD ANGLE PROJECTION											

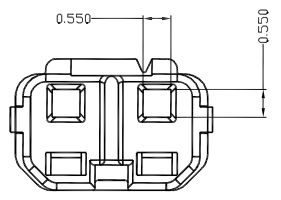
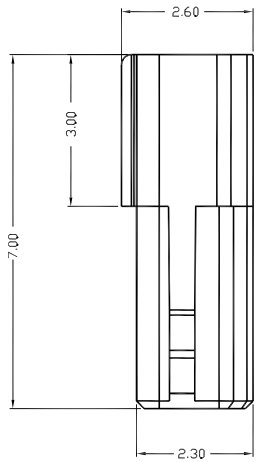
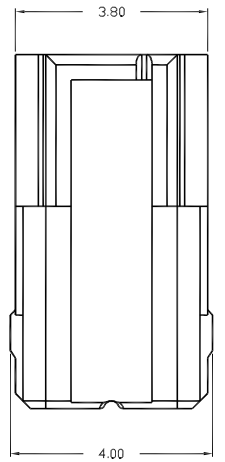
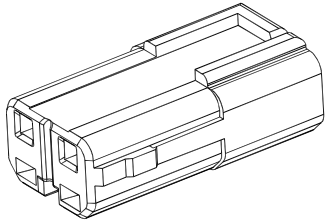
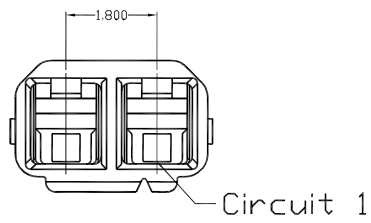

Specifications:

- Current Rating: 3.2A AC/DC
- Voltage rating: 350V AC/DC
- Temperature range: -25°C to +85°C
- Contact resistance: 10mΩ max.
- Insulation resistance: 1000MΩ min.
- Withstand voltage: 1500V AC/minute

Material:

Housing: nylon 66, UL94V-0, white

Mates with: 1801BRS (header, R/A, SMT type)

Used with: 1801TF-PT (female terminal)

Part Number Information:

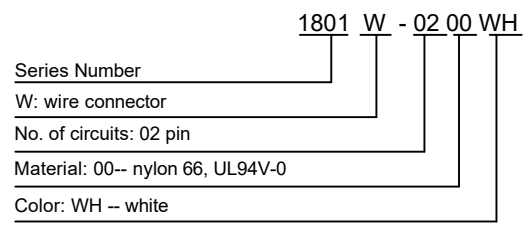

							General Tolerance	<h1>Zeakka Electronics</h1>				Document No.: ZK-1801W						
							.X ±0.3					Title: HOUSING, FEMALE, CRIMP TYPE, SINGLE ROW, 1.80MM PITCH						
							.XX ±0.2					APPR	CH'K	DRWN	Date	Dimensions	Scale	Version
							.XXX ±0.1					Kai Lee	Cris Wang	Jun Wei	2020.8.7	mm	1:1	A
Date	Version	EC No.	Description	DRWN	CH'K	APPR	THIRD ANGLE PROJECTION											

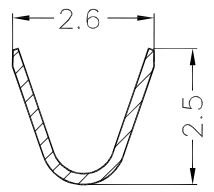
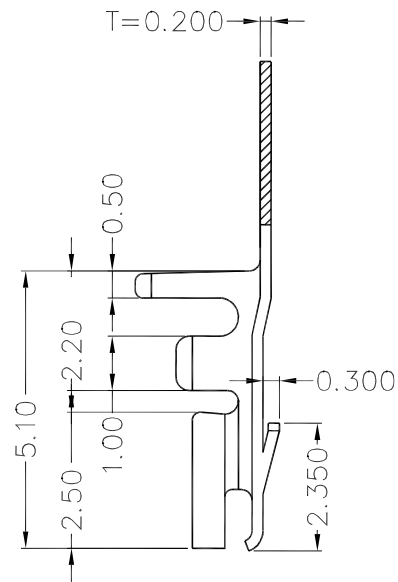
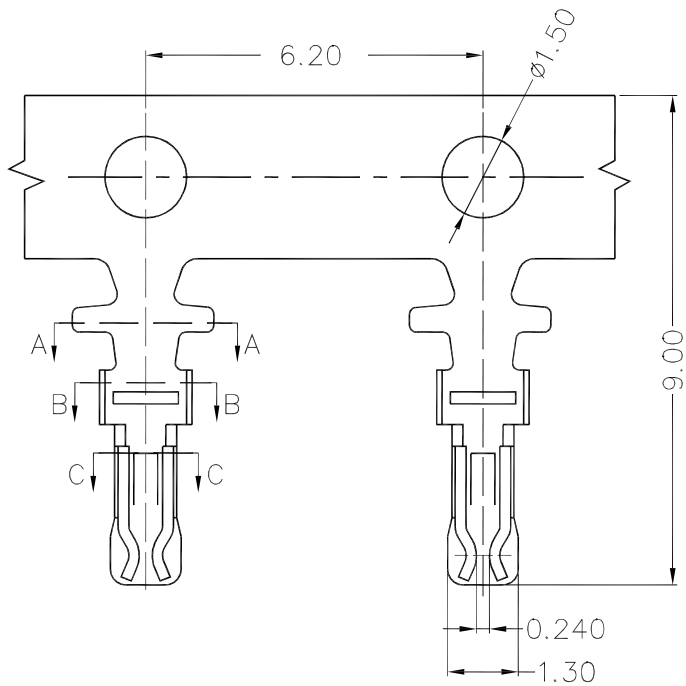

SECTION A-A
SCALE 1:1

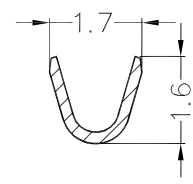

SECTION B-B
SCALE 1:1

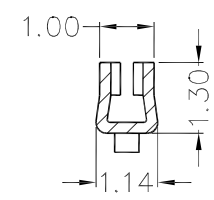

SECTION C-C
SCALE 1:1

Specifications:

- Current Rating: 3.2A AC/DC
- Voltage rating: 350V AC/DC
- Temperature range: -25°C to +85°C
- Contact resistance: 10mΩ max.
- Insulation resistance: 1000MΩ min.
- Withstand voltage: 1500V AC/minute
- Applicable wire: AWG26 - AWG22
- Insulation OD: max 1.30mm

Material:

Phosphor bronze

Used with: 1801W (female housing)
1801WL (female housing, with lock)

Part Number Information:

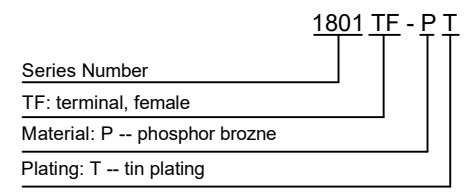

							General Tolerance	Zeakka Electronics				Document No.: ZK-1801TF						
							.X ±0.3					Title: TERMINAL, FEMALE, CRIMP TYPE, PHOSPHOR BRONZE, TIN, REEL						
							.XX ±0.2					APPR	CH'K	DRWN	Date	Dimensions	Scale	Version
							.XXX ±0.1					Kai Lee	Cris Wang	Jun Wei	2020.8.7	mm	1:1	A
Date	Version	EC No.	Description	DRWN	CH'K	APPR	THIRD ANGLE PROJECTION											