

Specifications:

Current Rating: 10.0A AC/DC
 Voltage rating: 300V AC/DC
 Temperature range: -25°C to +85°C
 Contact resistance: 15mΩ max.
 Insulation resistance: 1000MΩ min.
 Withstand voltage: 1500V AC/minute

Material:

Housing: nylon 66, UL94V-0, white

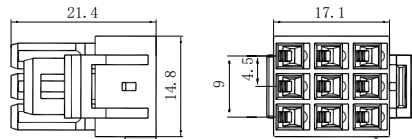

Part Number: 4502WF-T0900WH

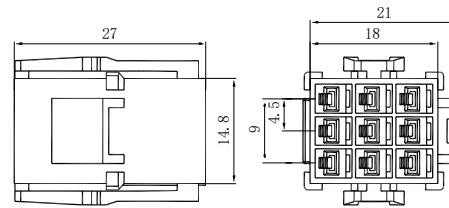

Part Number: 4502WM-T0900WH

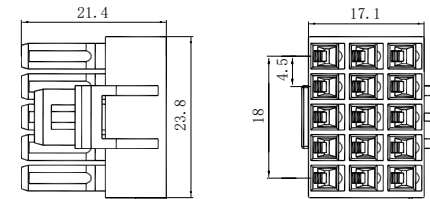

Part Number: 4502WF-T1500WH

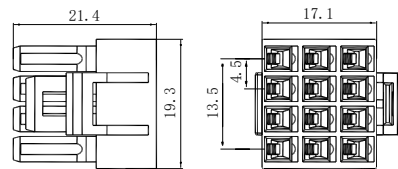

Part Number: 4502WF-T1200WH

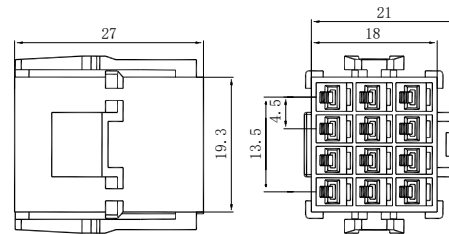

Part Number: 4502WM-T1200WH

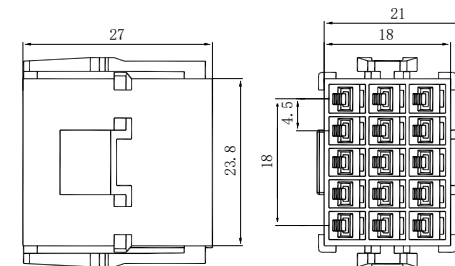

Part Number: 4502WM-T1500WH

							General Tolerance	<h1>Zeakka Electronics</h1>				Document No.: ZK-4502W-T						
							.X ±0.3					Title: HOUSING, CRIMP TYPE, TRIPLE ROW, 4.5MM PITCH						
							.XX ±0.2					APPR	CH'K	DRWN	Date	Dimensions	Scale	Version
							.XXX ±0.1					Kai Lee	Cris Wang	Jun Wei	2020.8.8	mm	1:1	A
Date	Version	EC No.	Description	DRWN	CH'K	APPR	THIRD ANGLE PROJECTION											

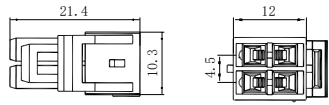

Part Number: 4502WF-D0400WH

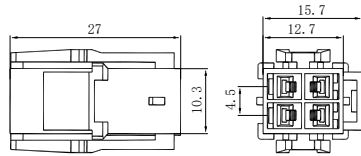

Part Number: 4502WM-D0400WH

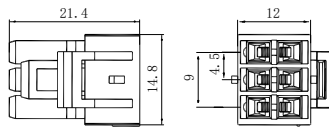
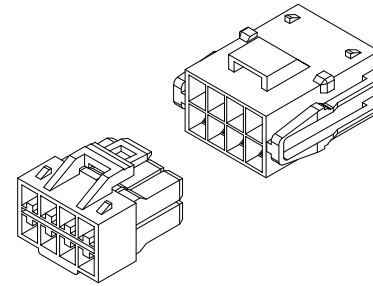

Part Number: 4502WF-D0600WH

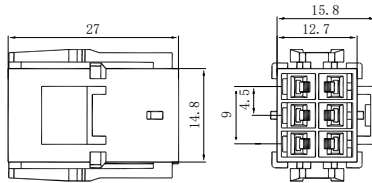

Part Number: 4502WM-D0600WH

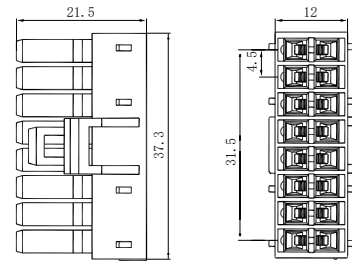

Part Number: 4502WF-D1600WH

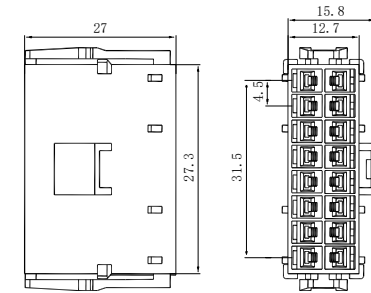

Part Number: 4502WM-D1600WH

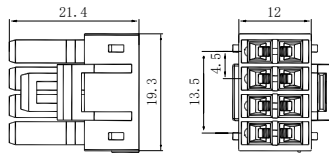

Part Number: 4502WF-D0800WH

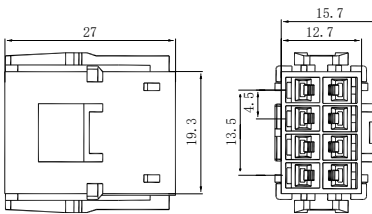

Part Number: 4502WM-D0800WH

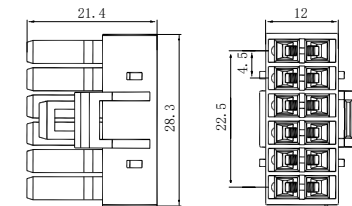

Part Number: 4502WF-D1200WH

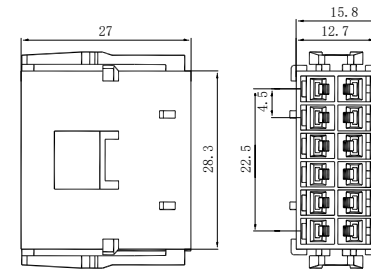

Part Number: 4502WM-D1200WH

Specifications:

Current Rating: 10.0A AC/DC
 Voltage rating: 300V AC/DC
 Temperature range: -25°C to +85°C
 Contact resistance: 15mΩ max.
 Insulation resistance: 1000MΩ min.
 Withstand voltage: 1500V AC/minute

Material:

Housing: nylon 66, UL94V-0, white

General Tolerance

.X ±0.3
 .XX ±0.2
 .XXX ±0.1

Zeakka Electronics

Document No.: ZK-4502W-D

Title: HOUSING, CRIMP TYPE, DUAL ROW, 4.5MM PITCH

Date	Version	EC No.	Description	DRWN	CH'K	APPR	THIRD ANGLE PROJECTION	APPR	CH'K	DRWN	Date	Dimensions	Scale	Version
								Kai Lee	Cris Wang	Jun Wei	2020.8.8	mm	1:1	A

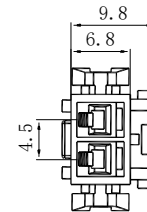
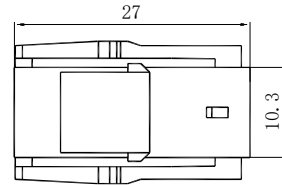
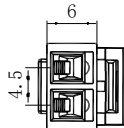
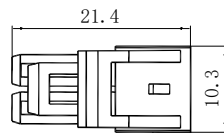
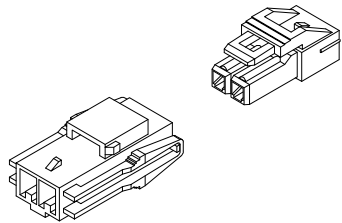

Part Number: 4502WF-S0200WH

Part Number: 4502WM-S0200WH

Specifications:

Current Rating: 10.0A AC/DC
 Voltage rating: 300V AC/DC
 Temperature range: -25°C to +85°C
 Contact resistance: 15mΩ max.
 Insulation resistance: 1000MΩ min.
 Withstand voltage: 1500V AC/minute

Material:

Housing: nylon 66, UL94V-0, white

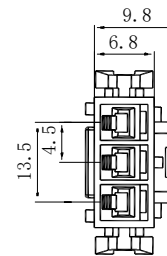
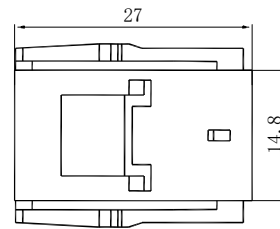
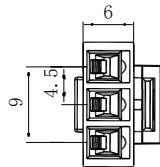
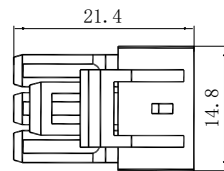
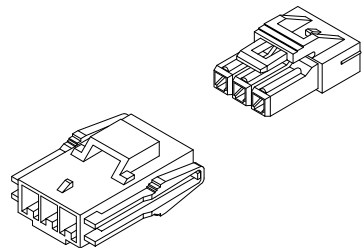

Part Number: 4502WF-S0300WH

Part Number: 4502WM-S0300WH

							General Tolerance	Zeakka Electronics				Document No.: ZK-4502W-S				
							.X ±0.3					APPR CH'K DRWN Date Kai Lee Cris Wang Jun Wei 2020.8.8			Title: HOUSING, CRIMP TYPE, SINGLE ROW, 4.5MM PITCH	
							.XX ±0.2								Dimensions	Scale
Date	Version	EC No.	Description	DRWN	CH'K	APPR	THIRD ANGLE PROJECTION					mm	1:1	A		
							.XXX ±0.1									

Specifications:

Current Rating: 10.0A AC/DC
 Voltage rating: 300V AC/DC
 Temperature range: -25°C to +85°C
 Contact resistance: 15mΩ max.
 Insulation resistance: 1000MΩ min.
 Withstand voltage: 1500V AC/minute
 Applicable wire: AWG28 - AWG16
 Insulation OD: max 2.70mm
 Package: reel

Material:

Phosphor bronze

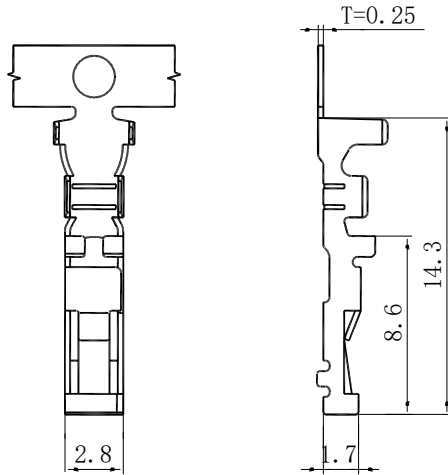

Part Number: 4502TF-PT

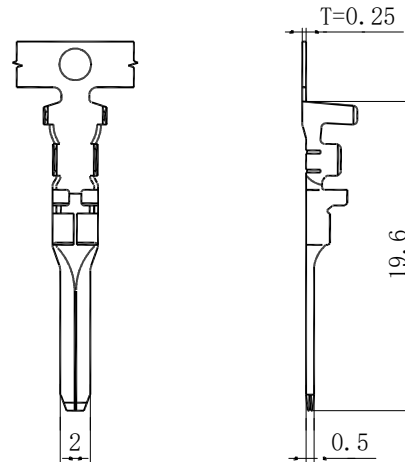

Part Number: 4502TM-PT

Zeakka Electronics

Document No.: ZK-4502T

Title: TERMINAL, CRIMP TYPE, PHOSPHOR BRONZE, TIN, REEL

General Tolerance

.X ±0.3

.XX ±0.2

.XXX ±0.1

APPR

CH'K

DRWN

Date

Dimensions

Scale

Version

Date Version EC No. Description DRWN CH'K APPR

THIRD ANGLE PROJECTION

Kai Lee

Cris Wang

Jun Wei

2020.8.8

mm

1:1

A