

P.C.B LAYOUT

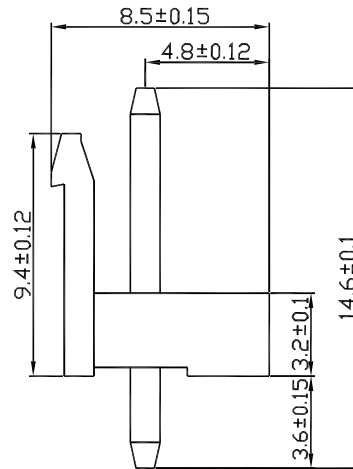
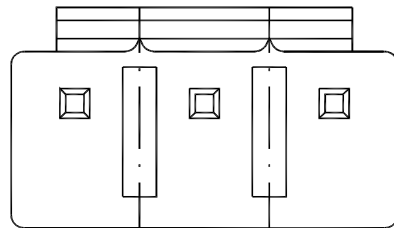

Specifications:

Current Rating: 7.0A AC/DC
 Voltage rating: 250V AC/DC
 Temperature range: -25°C to +85°C
 Contact resistance: 10mΩ max.
 Insulation resistance: 1000MΩ min.
 Withstand voltage: 1500V AC/minute

Circuits	Dimensions (mm)	
	A	B
2	5.00	10.00
3	10.00	15.00
4	15.00	20.00

Material:

Housing: nylon 66, UL94V-0, white
 PIN: brass

Mates with: 5001W (wire connector)

Part Number Information:

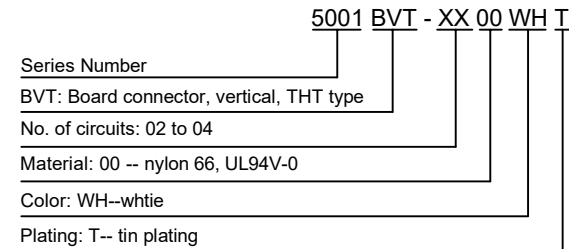

							General Tolerance	Zeakka Electronics				Document No.: ZK-5001BVT		
							.X ±0.3					Title: HEADER, VERTICAL, THT TYPE, SINGLE ROW, 5.0MM PITCH, TIN		
							.XX ±0.2	APPR	CH'K	DRWN	Date	Dimensions	Scale	Version
Date	Version	EC No.	Description	DRWN	CH'K	APPR	.XXX ±0.1	Kai Lee	Cris Wang	Jun Wei	2020.8.8	mm	1:1	A
							THIRD ANGLE PROJECTION							

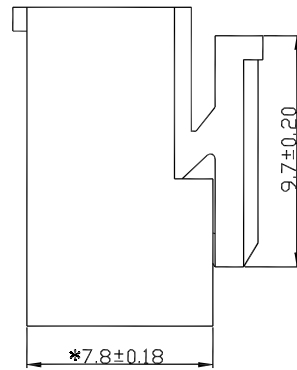
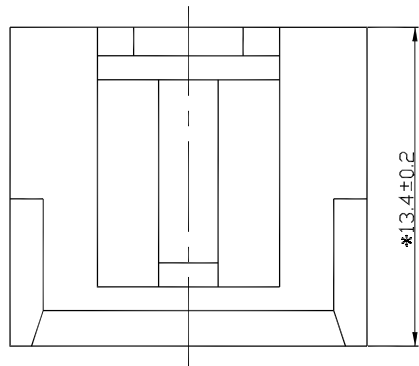
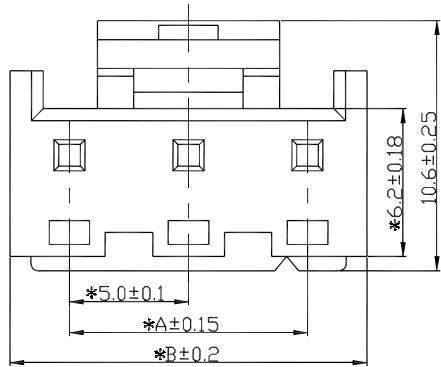

Circuits	Dimensions (mm)	
	A	B
2	5.00	10.00
3	10.00	15.00
4	15.00	20.00

Specifications:

Current Rating: 7.0A AC/DC
 Voltage rating: 250V AC/DC
 Temperature range: -25°C to +85°C
 Contact resistance: 10mΩ max.
 Insulation resistance: 1000MΩ min.
 Withstand voltage: 1500V AC/minute

Material:

Housing: nylon 66, UL94V-0, white

Mates with: 5001BVT (header, vertical, THT type)

Used with: 5001TF-PT (terminal)

Part Number Information:

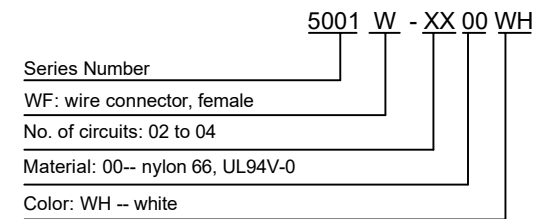

							General Tolerance	Zeakka Electronics				Document No.: ZK-5001W			
							.X ±0.3					Title: HOUSING, FEMALE, CRIMP TYPE, SINGLE ROW, 5.0MM PITCH			
							.XX ±0.2	APPR	CH'K	DRWN	Date	Dimensions	Scale	Version	
Date	Version	EC No.	Description	DRWN	CH'K	APPR	.XXX ±0.1	Kai Lee	Cris Wang	Jun Wei	2020.8.8	mm	1:1	A	
							THIRD ANGLE PROJECTION								

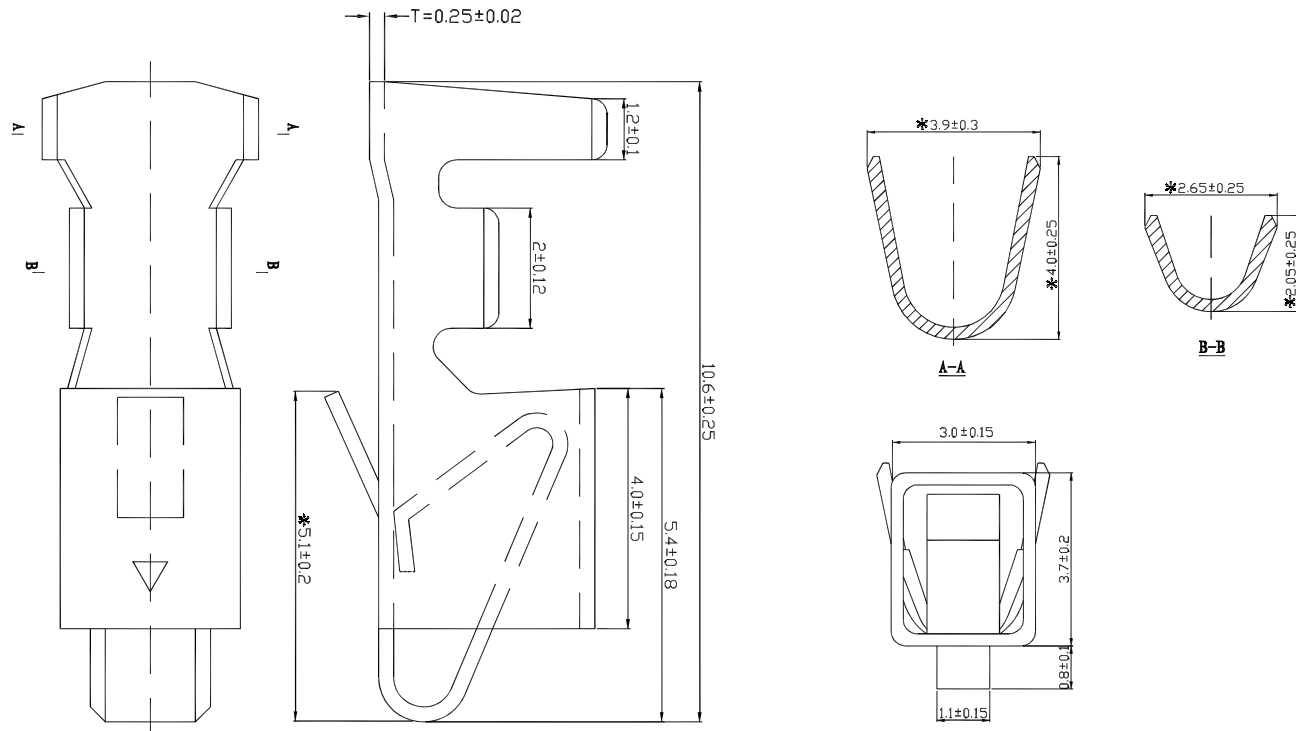

Specifications:

Current Rating: 7.0A AC/DC
 Voltage rating: 250V AC/DC
 Temperature range: -25°C to +85°C
 Contact resistance: 10mΩ max.
 Insulation resistance: 1000MΩ min.
 Withstand voltage: 1500V AC/minute
 Applicable wire: AWG22 - AWG18
 Insulation OD: max 3.0mm
 Package: reel

Material:

Phosphor bronze

Used with: 5001W (wire connector)

Part Number Information:

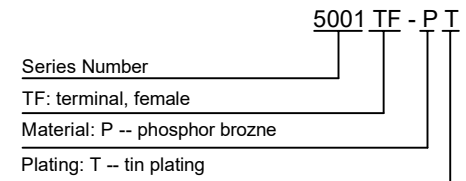

							General Tolerance	<h1 style="text-align: center;">Zeakka Electronics</h1>				Document No.: ZK-5001TF		
							.X ±0.3					Title: TERMINAL, FEMALE, CRIMP TYPE, PHOSPHOR BRONZE, TIN, REEL		
							.XX ±0.2					APPR	CH'K	DRWN
Date	Version	EC No.	Description	DRWN	CH'K	APPR	.XXX ±0.1	Kai Lee	Cris Wang	Jun Wei	2020.8.8	mm	1:1	A
							THIRD ANGLE PROJECTION							